

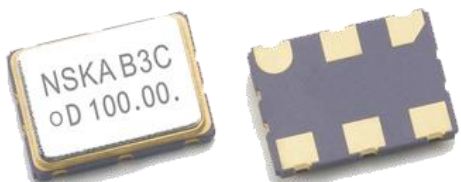











NADD Series 7.0 x 5.0

  	Application : <ul style="list-style-type: none">  XDSL / VoIP, Cable modem  Jitter Attenuator, ADC  Set-top Box, HDTV  WiMAX / WLAN
	Features : <ul style="list-style-type: none">  Low phase jitter (12KHz to 20MHz) under 1 ps (RMS)  Tri-state function available  RoHS compliant / Pb free  Differential output



Electrical Specification :

Model		NADD-75
1. Frequency		
Frequency Range	MHz	25.0 ~ 200.0
Frequency Stability	PPM	A: ±100 B: ±50 C: ±30 D: ±25
2. Temperature Range		
Operating Temp Range	°C	-10 ~ +70, -40 ~ +85 or specify
Storage Temp Range	°C	-55 ~ +125
Output Voltage High (V _{OH})	V (Min.)	0.9
Output Voltage Low (V _{OL})	V (Max.)	1.6
Output Load	Ω	100
Output Symmetry	%	45% ~ 55%
3. Input Voltage		
Enable High Input Voltage	V (Min.)	0.7 VDD
Enable Low Input Voltage	V (Max.)	0.3 VDD
Current	mA (Max.)	80
Rise / Fall Time (20% / 80%)	nS (Max.)	1.0
Aging	Ppm / Year	±3
Start Up Time	mS (Max.)	10

* Above specification subject to change without prior notice, please consult our sales representative for more information*

TAIWAN — JENJAAN QUARTEK CORPORATION

Address : 3F-5, No 504 Yun Shan Road, Chung Ho City, Taipei, Taiwan
 Tel : +886-2-8221-4498 Fax : +886-2-8221-4499
 E-mail : jenjaan@jenjaan.com.tw Web : http://www.nsk.com.tw

FACTORY - DONG GUAN ALLIED PROJECT LIMITED

Address : No. 703, Fu Min Zhong Road, Yang Yong Village, Dalang
 Town, Dong Guan, Guang Dong, China Tel : +86-769-8311-9395
 Fax : +86-769-8313-0880 E-mail : alliedj@pub.dgnet.gd.cn

SMD TYPE LVDS CRYSTAL OSCILLATORS



Dimensions (mm) :

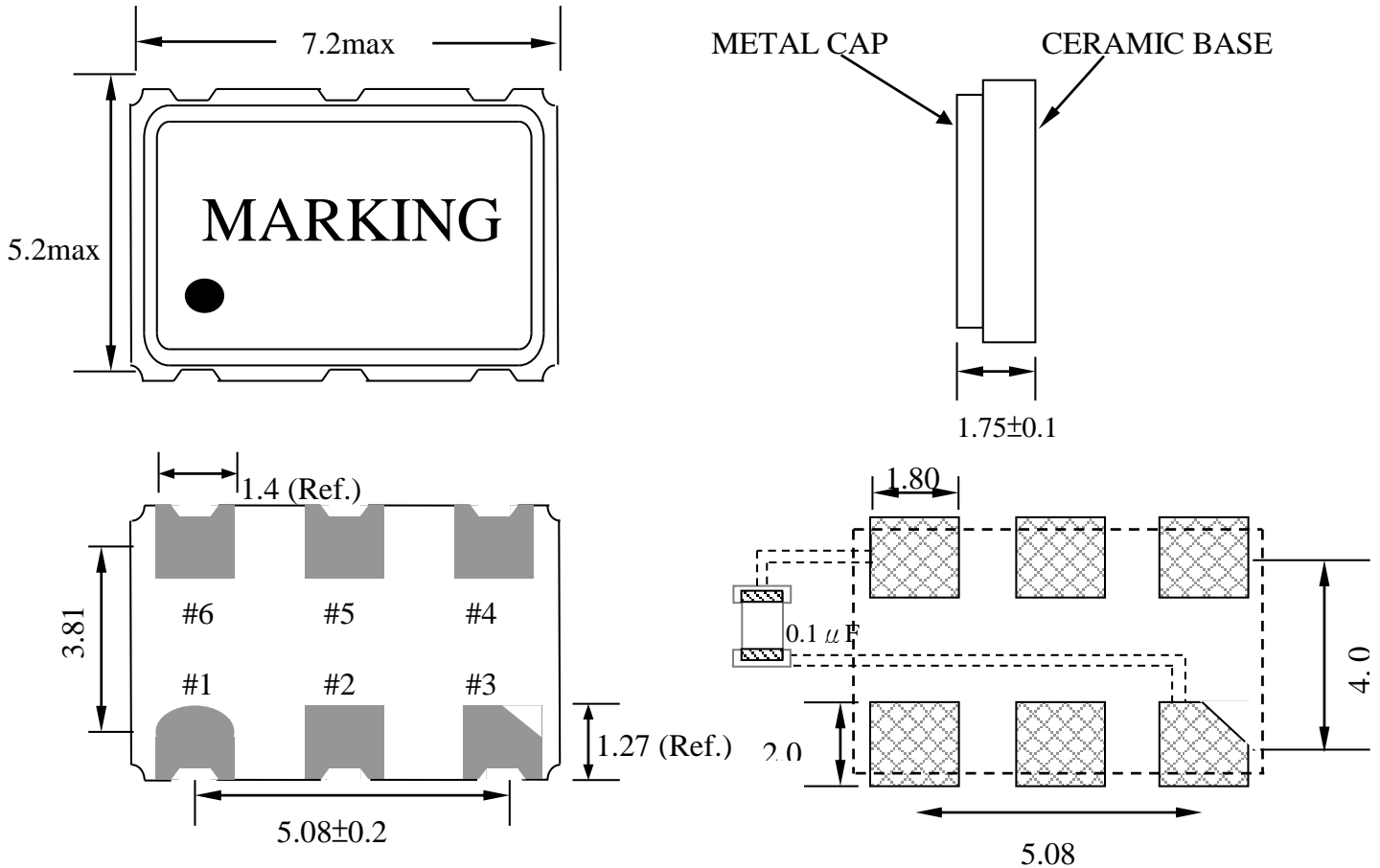

# NO.: Pin define		
#6: VDD	#5: Comp Output	#4: Output
#1: Vcon	#2: Tri-State	#3: GND

* Above specification subject to change without prior notice, please consult our sales representative for more information*

TAIWAN — JENJAAN QUARTEK CORPORATION

Address : 3F-5, No 504 Yun Shan Road, Chung Ho City, Taipei, Taiwan
 Tel : +886-2-8221-4498 Fax : +886-2-8221-4499
 E-mail : jenjaan@jenjaan.com.tw Web : http://www.nsk.com.tw

FACTORY - DONG GUAN ALLIED PROJECT LIMITED

Address : No. 703, Fu Min Zhong Road, Yang Yong Village, Dalang
 Town, Dong Guan, Guang Dong, China Tel : +86-769-8311-9395
 Fax : +86-769-8313-0880 E-mail : alliedj@pub.dgnet.gd.cn

Tape Specification(mm) :

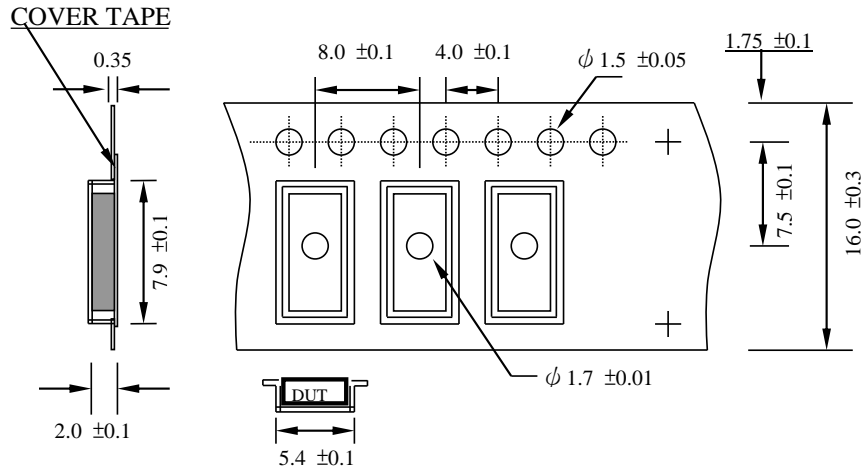

Reel Packing(mm) :

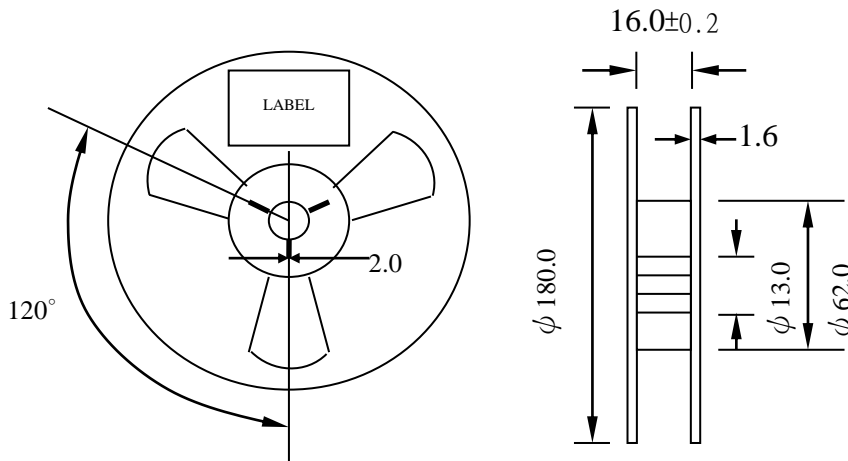

Reflow Temperature Profile :

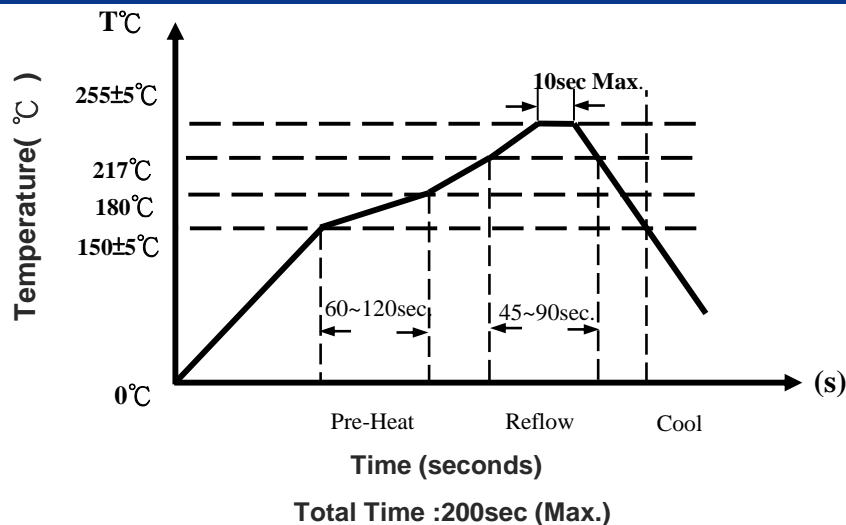

* Above specification subject to change without prior notice, please consult our sales representative for more information*

TAIWAN — JENJAAN QUARTEK CORPORATION

Address : 3F-5, No 504 Yun Shan Road, Chung Ho City, Taipei, Taiwan

Tel : +886-2-8221-4498

E-mail : jenjaan@jenjaan.com.tw

Fax : +886-2-8221-4499

Web : <http://www.nsk.com.tw>

FACTORY - DONG GUAN ALLIED PROJECT LIMITED

Address : No. 703, Fu Min Zhong Road, Yang Yong Village, Dalang

Town, Dong Guan, Guang Dong, China Tel : +86-769-8311-9395

Fax : +86-769-8313-0880

E-mail : alliedj@pub.dgnet.gd.cn