















NAOH Series 5.0 x 3.2

   	Application : <ul style="list-style-type: none">  Portable PC / Digital camera  Wireless Lan / DOA Terminal  Portable multimedia player  PCMCIA card / SD card  CCD / HDD
	Features : <ul style="list-style-type: none">  Low power consumption  RoHS compliant / Pb free  Excellent solderability  Seam welding  Tri-State

Electrical Specification :

Model		NAOH-53				
1. Frequency						
Frequency Range	MHz	1.0 ~ 170.0				
Frequency Stability	PPM	A: ±100 B: ±50 C: ±30 D: ±25				
Operating Temp Range	°C	0 ~ +70, -40 ~ +85 or specify				
Storage Temp Range	°C	-55 ~ +125				
Output Level		CMOS				
Output Symmetry	%	40% ~ 60% or 45% ~ 55% (at 55%VDC)				
Power Supply Voltage	VDC	5.0V±10%	3.3V±10%	2.8V±5%	2.5V±5%	1.8V±5%
2. Current Consumption						
1.00 MHz ~ 9.99 MHz	mA Max.	20	7	6	6	5
10.00 MHz ~ 19.99 MHz		20	7	8	8	6
20.00 MHz ~ 31.99 MHz		25	12	8	8	6
32.00 MHz ~ 49.99 MHz		35	20	20	20	15
50.00 MHz ~ 79.99 MHz		50	25	20	20	15
80.00 MHz ~ 99.99 MHz		60	30	-	20	20

* Above specification subject to change without prior notice, please consult our sales representative for more information*

TAIWAN — JENJAAN QUARTEK CORPORATION

Address : 3F-5, No 504 Yun Shan Road, Chung Ho City, Taipei, Taiwan
 Tel : +886-2-8221-4498 Fax : +886-2-8221-4499
 E-mail : jjenjaan@jenjaan.com.tw Web : http://www.nsk.com.tw

FACTORY - DONG GUAN ALLIED PROJECT LIMITED

Address : No. 703, Fu Min Zhong Road, Yang Yong Village, Dalang
 Town, Dong Guan, Guang Dong, China Tel : +86-769-8311-9395
 Fax : +86-769-8313-0880 E-mail : alliedj@pub.dgnet.gd.cn

SMD TYPE CERAMIC OSCILLATORS



100.0 MHz ~ 170.0 MHz		80	40	-	30	25
3. Rise and Fall Time						
1.00 MHz ~ 9.99 MHz	ns Max.	15	20	5	5	5
10.00 MHz ~ 19.99 MHz		15	15	5	5	5
20.00 MHz ~ 31.99 MHz		15	10	5	5	5
32.00 MHz ~ 49.99 MHz		15	10	5	5	5
50.00 MHz ~ 79.99 MHz		10	8	5	5	4
80.00 MHz ~ 99.99 MHz		10	5	5	5	3
100.0 MHz ~ 170.0 MHz		10	4	5	5	3
4. Output Load	pF	15				
5. Aging	PPM/Year	±3				

Dimensions (mm) :

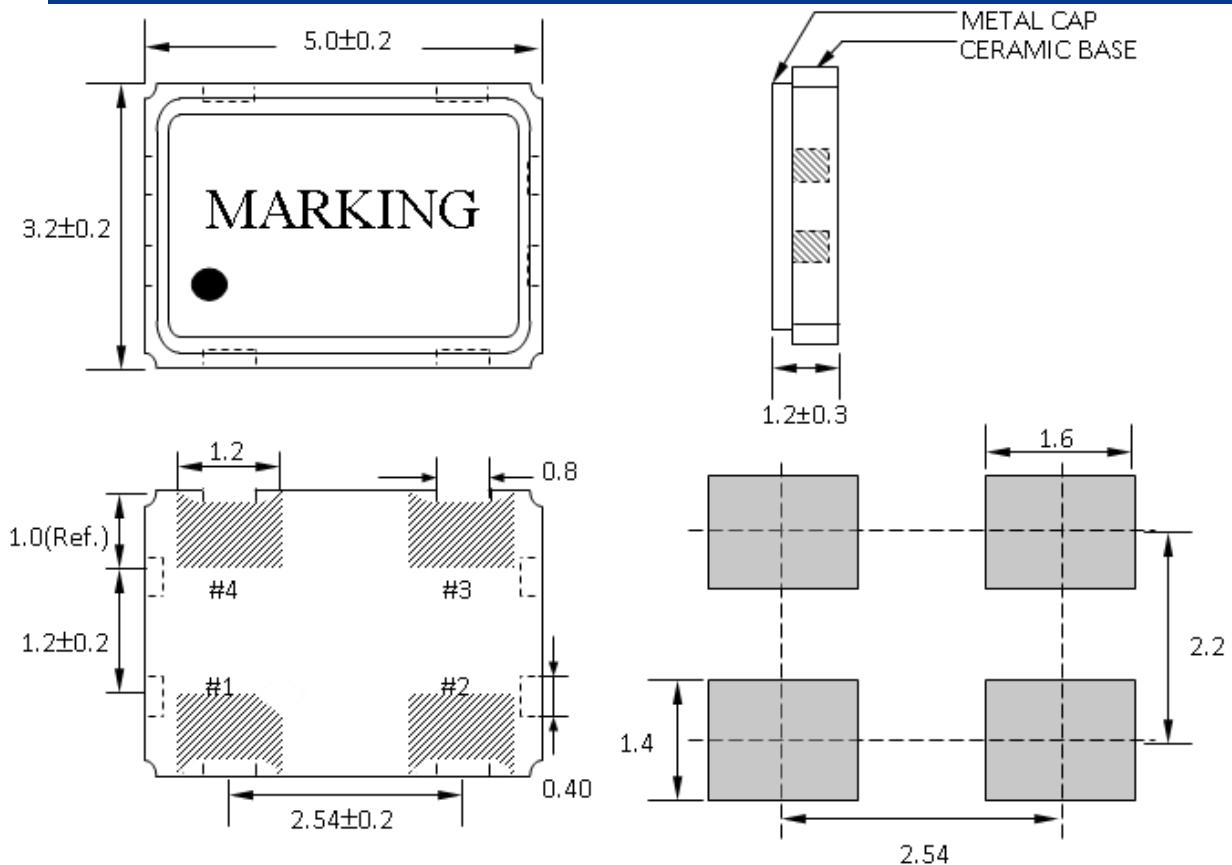

#1: ENABLE / DISABLE FUNCTION

INH (PIN 1) —————>	OUTPUT (PIN 3)	# NO.: define	
High (OPEN) —————>	Operating	#4: VDD	#3: OUTPUT
LOW —————>	High impedance	#1: E/D	#2: GND

* Above specification subject to change without prior notice, please consult our sales representative for more information*

TAIWAN — JENJAAN QUARTEK CORPORATION

Address : 3F-5, No 504 Yun Shan Road, Chung Ho City, Taipei, Taiwan

Tel : +886-2-8221-4498

E-mail : jenjaan@jenjaan.com.tw

Fax : +886-2-8221-4499

Web : http://www.nsk.com.tw

FACTORY - DONG GUAN ALLIED PROJECT LIMITED

Address : No. 703, Fu Min Zhong Road, Yang Yong Village, Dalang

Town, Dong Guan, Guang Dong, China Tel : +86-769-8311-9395

Fax : +86-769-8313-0880

E-mail : alliedj@pub.dgnet.gd.cn

Tape Specification(mm) :

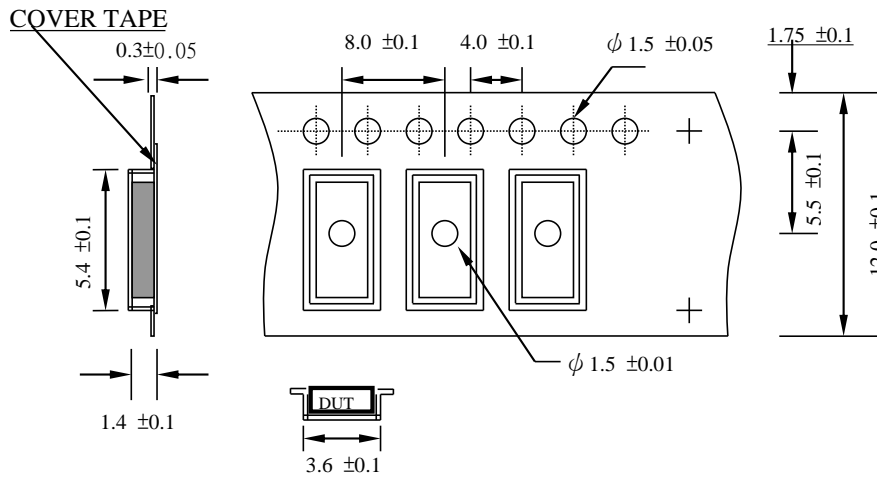

Reel Packing(mm) :

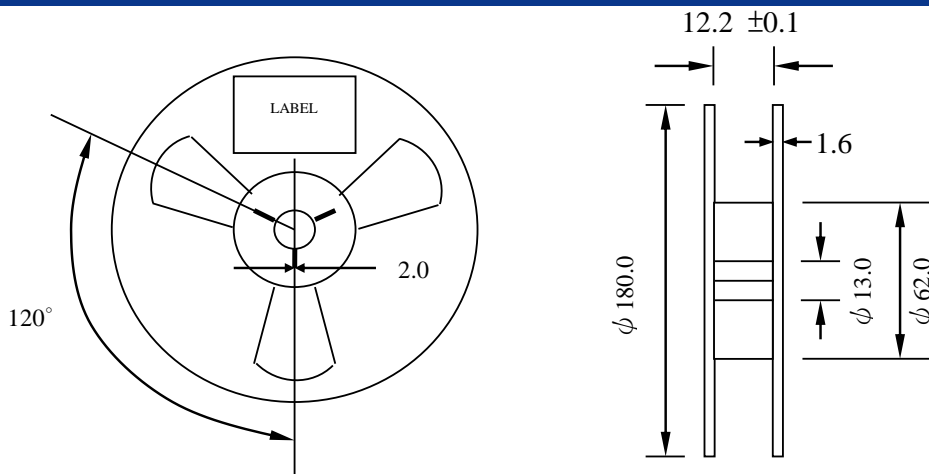

Reflow Temperature Profile :

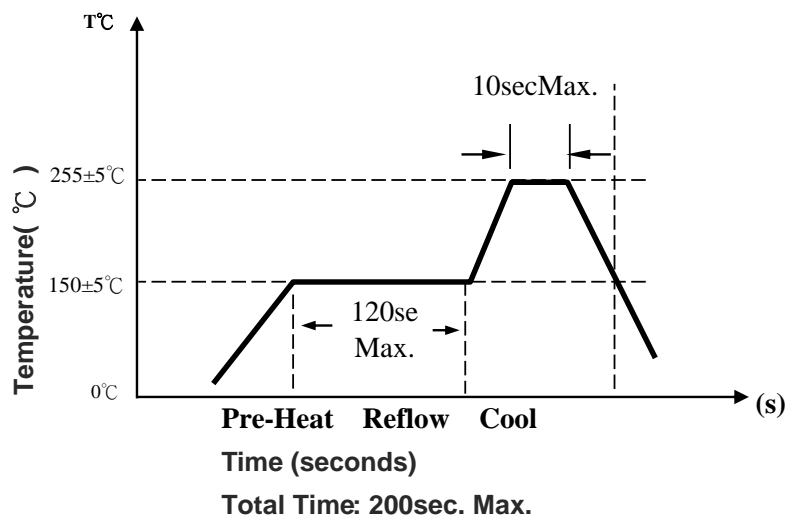

* Above specification subject to change without prior notice, please consult our sales representative for more information*

TAIWAN — JENJAAN QUARTEK CORPORATION

Address : 3F-5, No 504 Yun Shan Road, Chung Ho City, Taipei, Taiwan

Tel : +886-2-8221-4498

E-mail : jenjaan@jenjaan.com.tw

Fax : +886-2-8221-4499

Web : <http://www.nsk.com.tw>

FACTORY - DONG GUAN ALLIED PROJECT LIMITED

Address : No. 703, Fu Min Zhong Road, Yang Yong Village, Dalang

Town, Dong Guan, Guang Dong, China Tel : +86-769-8311-9395

Fax : +86-769-8313-0880

E-mail : alliedj@pub.dgnet.gd.cn