

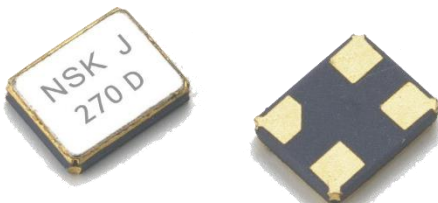













NXN Series 2.0 x 1.6

  	Application : <ul style="list-style-type: none">  Office automation equipment  Audio-visual equipment  Radio communication  GPS
	Features : <ul style="list-style-type: none">  Packing in embossed carrier tape realize auto SMT  Excellent vibration resistance & shock resistance  RoHS compliant / Pb free  Excellent solderability  Seam welding



Electrical Specification :

Model	NXN-21
1. Frequency	
Frequency Range	12.0 ~ 96.0 MHz
Frequency Tolerance at 25°C±2°C	±10 ~ ±50 ppm (TYP.)
Frequency Stability Over Operating Temp Range	±10 ~ ±50 ppm (TYP.)
2. Environmental Condition	
Operating Temp Range	-10°C~ +60°C, -20°C~ +70°C or specify
Storage Temp Range	-40°C ~ +125°C
Aging Rate	±3ppm/year
3. Electrical Specifications	
Test Circuit	S&A 250B
Load Capacitance	6pF ~ 32pF, series or specify
Drive Level	1uW ~ 100uW or specify
Shunt Capacitance	3.0pF max

* Above specification subject to change without prior notice, please consult our sales representative for more information*

TAIWAN — JENJAAN QUARTEK CORPORATION

Address : 3F-5, No 504 Yun Shan Road, Chung Ho City, Taipei, Taiwan

Tel : +886-2-8221-4498

Fax : +886-2-8221-4499

E-mail : jenjaan@jenjaan.com.tw

Web : http://www.nsk.com.tw

FACTORY - DONG GUAN ALLIED PROJECT LIMITED

Address : No. 703, Fu Min Zhong Road, Yang Yong Village, Dalang

Town, Dong Guan, Guang Dong, China Tel : +86-769-8311-9395

Fax : +86-769-8313-0880

E-mail : alliedj@pub.dgnet.gd.cn

SMD TYPE CERAMIC CRYSTAL UNIT



Equivalent Series Resistance (ESR) V.S. Frequency:

Frequency (MHz)	Oscillation Mode	NXN-21
20.0 MHz ~ 23.9 MHz	Fundamental	120Ω
24.0 MHz ~ 29.9 MHz	Fundamental	100Ω
30.0 MHz ~ 37.9 MHz	Fundamental	80Ω
38.0 MHz ~ 96.0 MHz	Fundamental	60Ω

Dimensions (mm) :

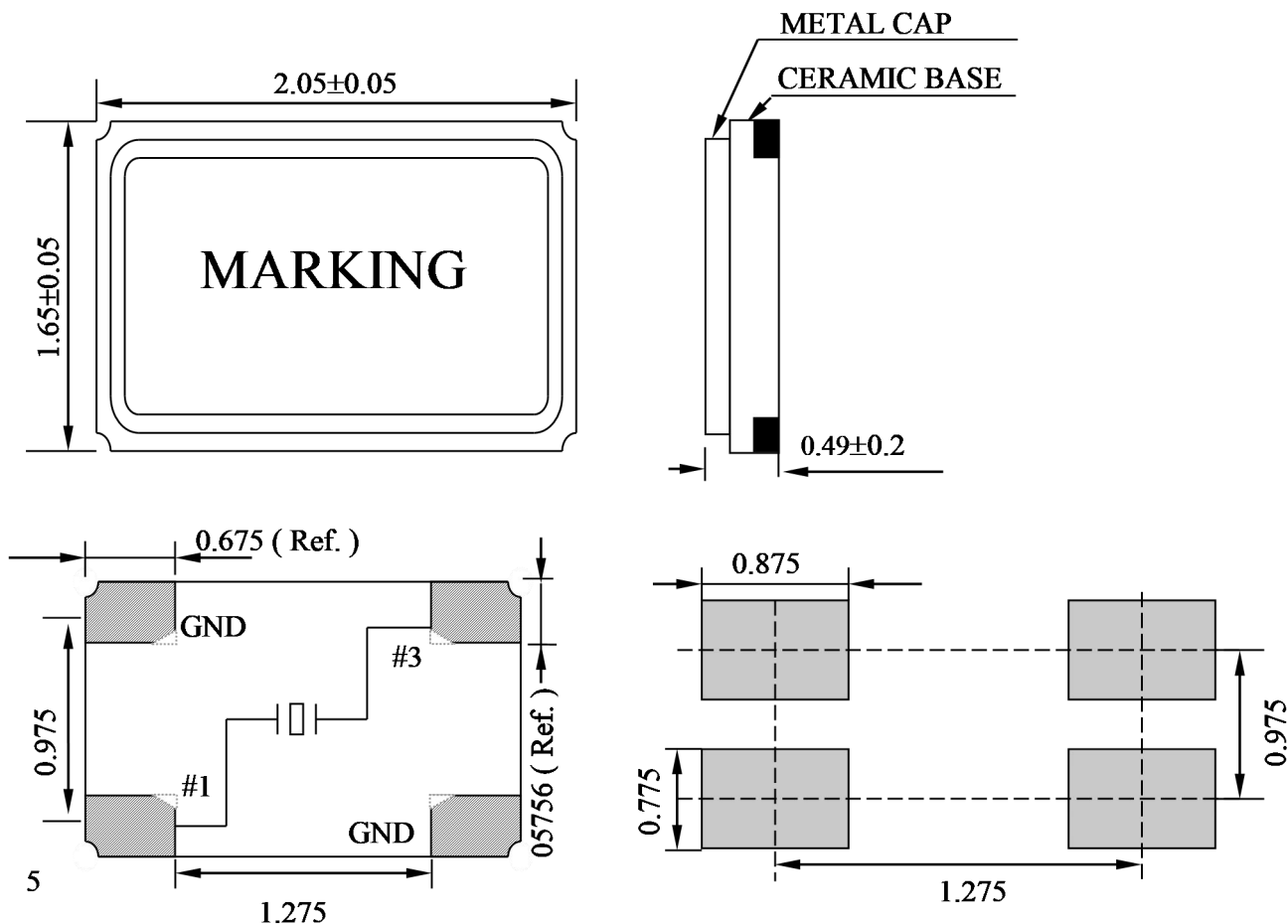

* Above specification subject to change without prior notice, please consult our sales representative for more information*

TAIWAN — JENJAAN QUARTEK CORPORATION

Address : 3F-5, No 504 Yun Shan Road, Chung Ho City, Taipei, Taiwan

Tel : +886-2-8221-4498

Fax : +886-2-8221-4499

E-mail : jenjaan@jenjaan.com.tw

Web : <http://www.nsk.com.tw>

FACTORY - DONG GUAN ALLIED PROJECT LIMITED

Address : No. 703, Fu Min Zhong Road, Yang Yong Village, Dalang

Town, Dong Guan, Guang Dong, China

Tel : +86-769-8311-9395

Fax : +86-769-8313-0880

E-mail : alliedj@pub.dgnet.gd.cn

Tape Specification(mm) :

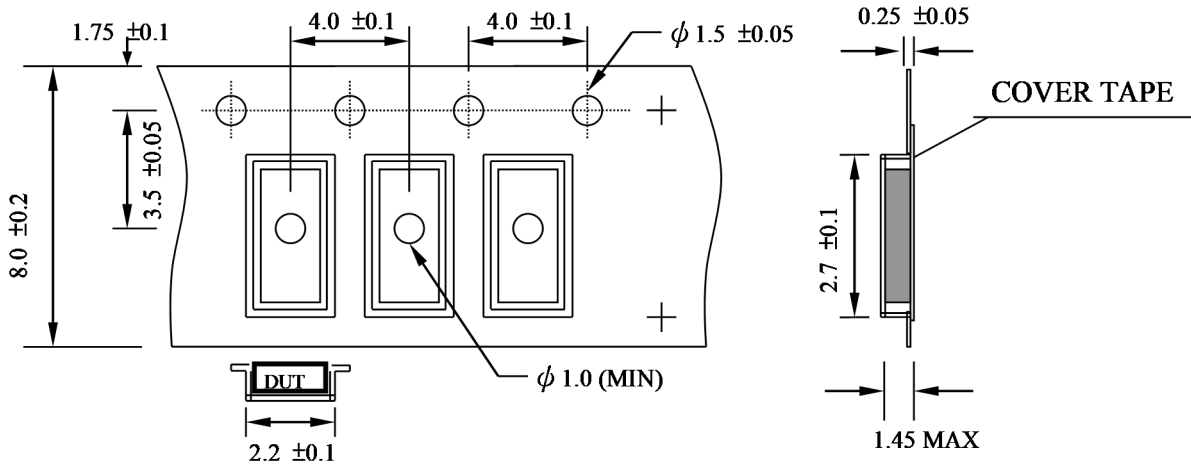

Reel Packing(mm) :

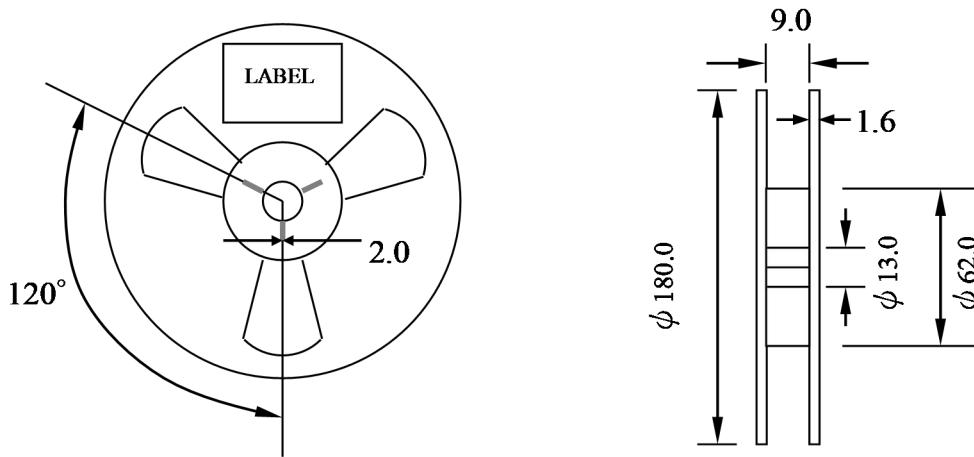

Reflow Temperature Profile :

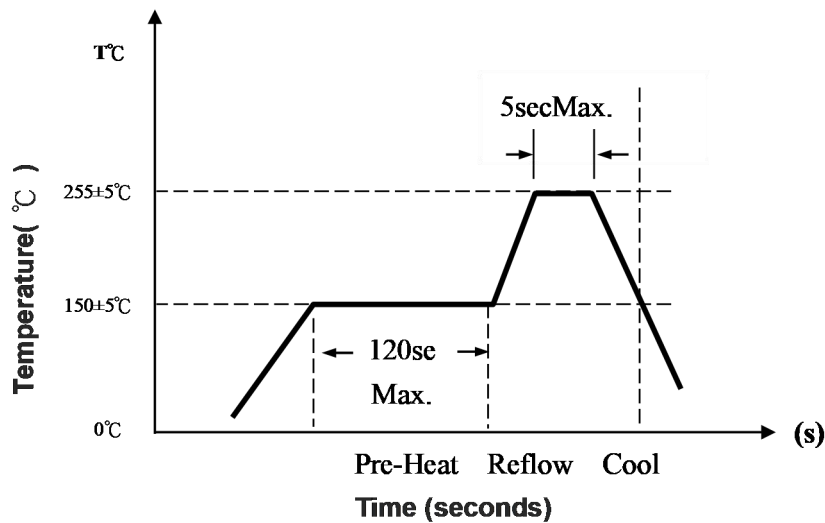

* Above specification subject to change without prior notice, please consult our sales representative for more information*

TAIWAN — JENJAAN QUARTEK CORPORATION

Address : 3F-5, No 504 Yun Shan Road, Chung Ho City, Taipei, Taiwan
Tel : +886-2-8221-4498 Fax : +886-2-8221-4499

E-mail : jenjaan@jenjaan.com.tw

Web : <http://www.nsk.com.tw>

FACTORY - DONG GUAN ALLIED PROJECT LIMITED

Address : No. 703, Fu Min Zhong Road, Yang Yong Village, Dalang
Town, Dong Guan, Guang Dong, China Tel : +86-769-8311-9395

Fax : +86-769-8313-0880

E-mail : alliedj@pub.dgnet.gd.cn